

**Vaskular**  
**Vascular**

**23**





**Nabatoff**  
**komplett/complete**  
135x100x25 mm **23-010-00**  
**Metalletui, allein 23-010-09**  
Metal case, only

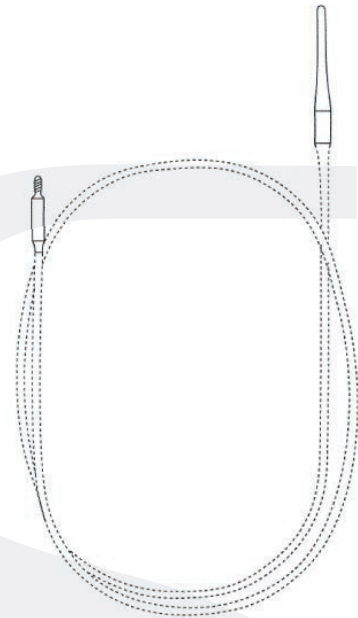

**Zugseil**  
Traction Cable  
90 cm **23-010-01**

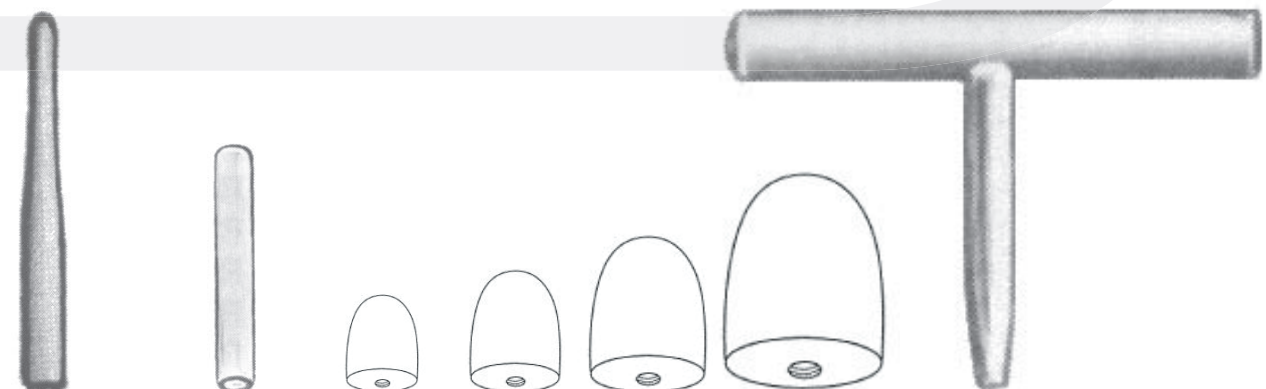

<b>Kunststoffspitze</b> Plastic Probe Tip	<b>Metallspitze</b> Metal Probe Tip	Ø 6,0 mm	Ø 9,0 mm	Ø 12,0 mm	Ø 15,0 mm	<b>Griff/Handle</b>
<b>23-010-02</b>	<b>23-010-03</b>	<b>23-010-04</b>	<b>23-010-05</b>	<b>23-010-06</b>	<b>23-010-07</b>	<b>23-010-08</b>

50,0 cm

50,0 cm

23-011-00, 11,0 cm

**Vollmar**  
**23-013-00**  
Satz/Set Ø 2,0 mm - 14,0 mm

**Vollmar**  
**23-014-00**  
Satz/Set 2,0 mm - 14,0 mm

- 23-013-02 Ø 2,0 mm
- 23-013-03 Ø 3,0 mm
- 23-013-04 Ø 4,0 mm
- 23-013-06 Ø 6,0 mm
- 23-013-07 Ø 7,0 mm
- 23-013-08 Ø 8,5 mm
- 23-013-10 Ø 10 mm
- 23-013-12 Ø 12 mm
- 23-013-14 Ø 14 mm
- 23-014-02 2,5x2 mm
- 23-014-03 3,6x3 mm
- 23-014-04 5,2x4 mm
- 23-014-05 6,5x5 mm
- 23-014-06 7,8x6 mm
- 23-014-07 9x7 mm
- 23-014-08 10,5x8 mm
- 23-014-09 11,5x9 mm
- 23-014-10 13x10 mm
- 23-014-12 16x12 mm
- 23-014-14 19x14 mm

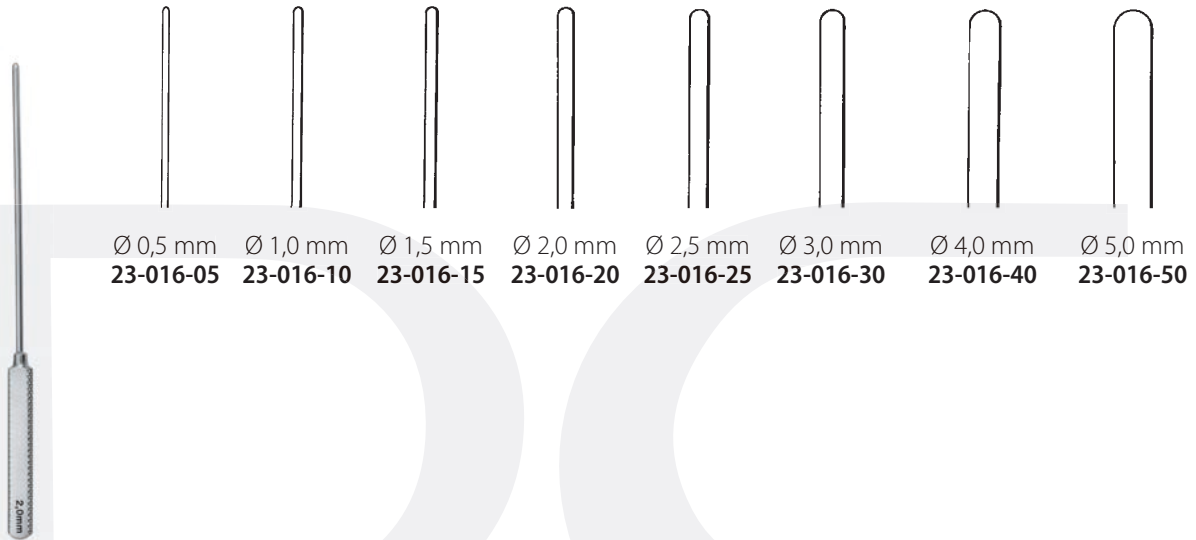

Ø 0,5 mm    Ø 1,0 mm    Ø 1,5 mm    Ø 2,0 mm    Ø 2,5 mm    Ø 3,0 mm    Ø 4,0 mm    Ø 5,0 mm  
**23-016-05    23-016-10    23-016-15    23-016-20    23-016-25    23-016-30    23-016-40    23-016-50**

**Cooley, 13,0 cm**

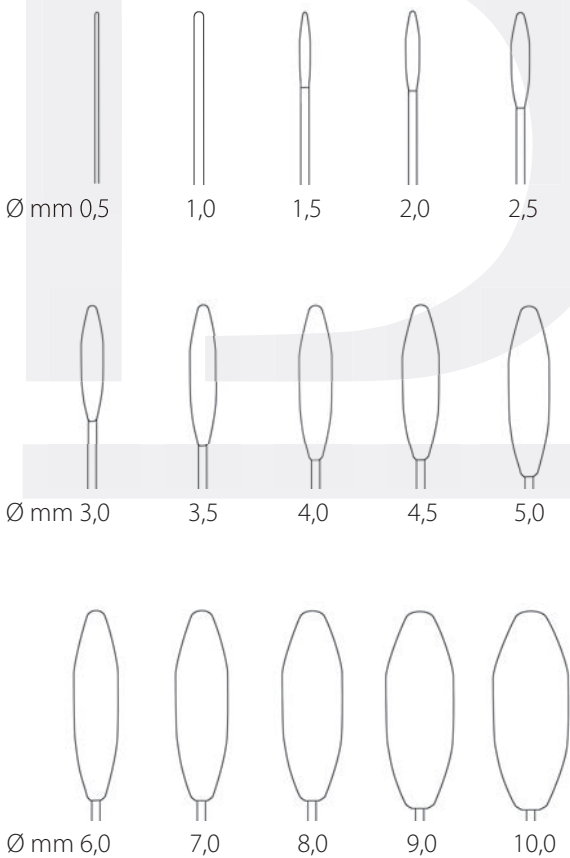

Ø mm 0,5

1,0

1,5

2,0

2,5

Ø mm 3,0

3,5

4,0

4,5

5,0

Ø mm 6,0

7,0

8,0

9,0

10,0

19,0 cm

35,0 cm

Ø mm

**23-018-05**

**23-019-05**

0,5

**23-018-10**

**23-019-10**

1,0

**23-018-15**

**23-019-15**

1,5

**23-018-20**

**23-019-20**

2,0

**23-018-25**

**23-019-25**

2,5

**23-018-30**

**23-019-30**

3,0

**23-018-35**

**23-019-35**

3,5

**23-018-40**

**23-019-40**

4,0

**23-018-45**

**23-019-45**

4,5

**23-018-50**

**23-019-50**

5,0

**23-018-60**

**23-019-60**

6,0

**23-018-70**

**23-019-70**

7,0

**23-018-80**

**23-019-80**

8,0

**23-018-90**

**23-019-90**

9,0

**23-018-99**

**23-019-99**

10,0



**De Bakey**

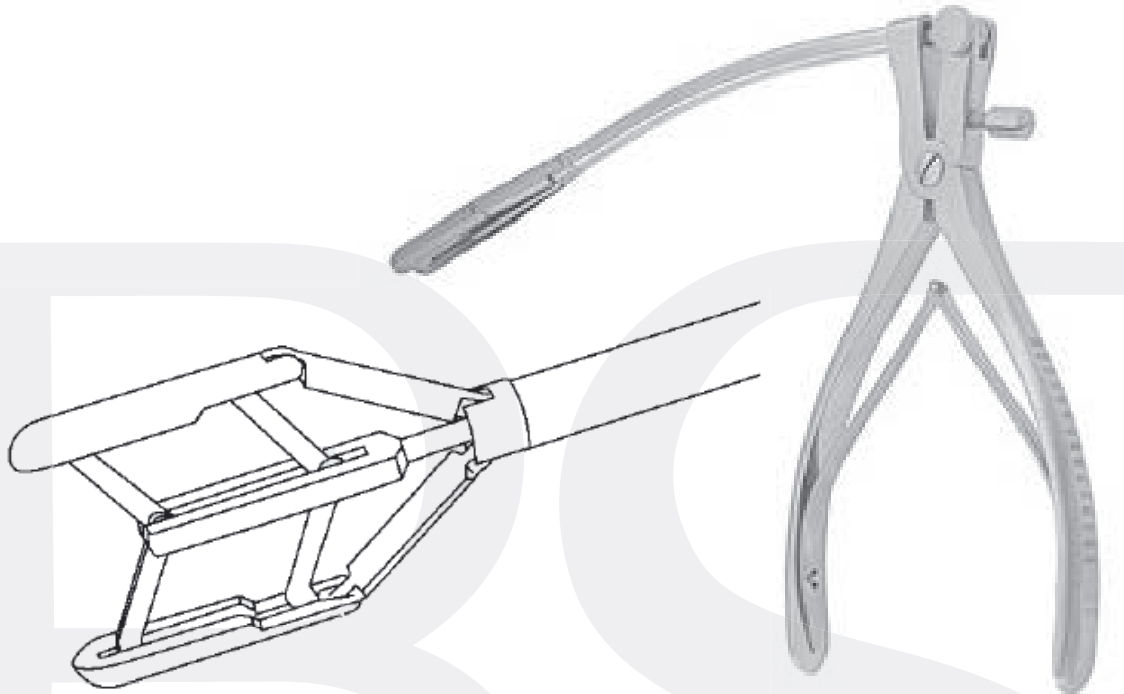

**Spreizweite 8 - 42 mm**  
Blade opening 8 - 42 mm

**Tubbs**  
23-030-00

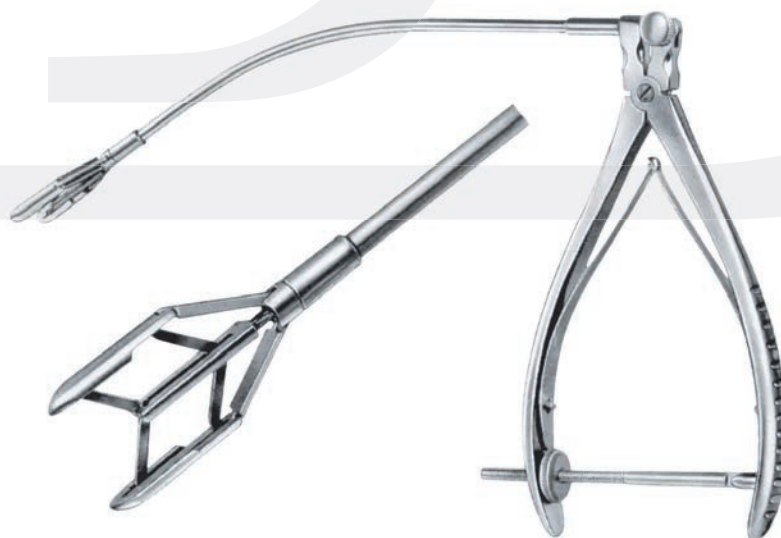

**Spreizweite 8 - 15 mm**  
Blade opening 8 - 15 mm

**Cooley**  
23-032-00

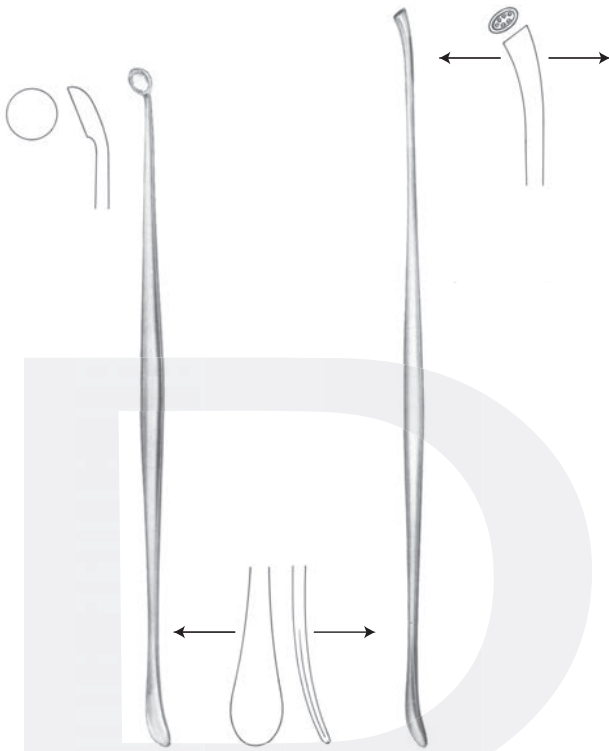

**Penfield, Fig. 1**  
17,5 cm **23-100-01**

**Penfield, Fig. 2**  
19,5 cm **23-100-02**

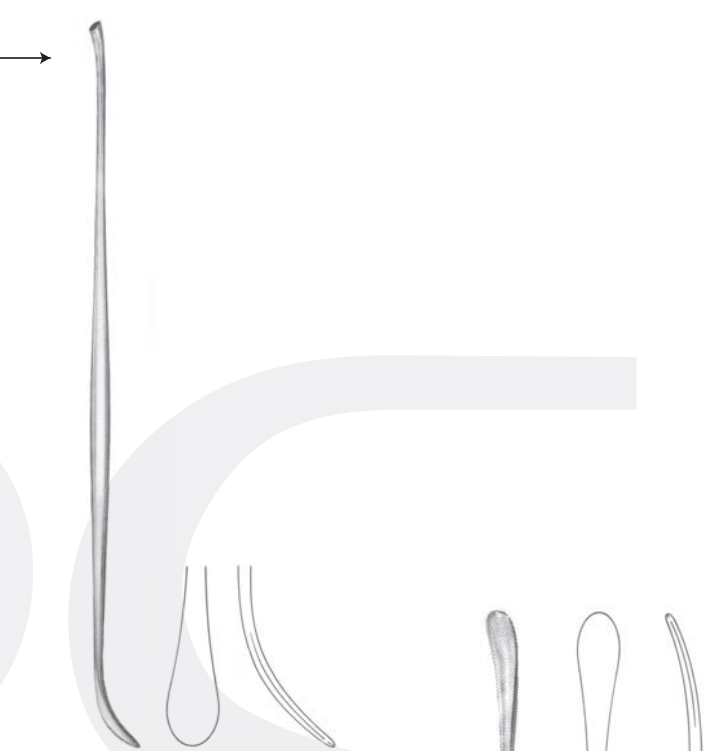

**Penfield, Fig. 3**  
19,5 cm **23-100-03**



**Penfield, Fig. 5**  
29,0 cm **23-100-05**



**Penfield, Fig. 4**  
20,5 cm **23-100-04**



**Halle**  
18,0 cm **23-102-18**



23,0 cm **23-104-23**



18,5 cm **23-107-18**  
21,5 cm **23-107-21**

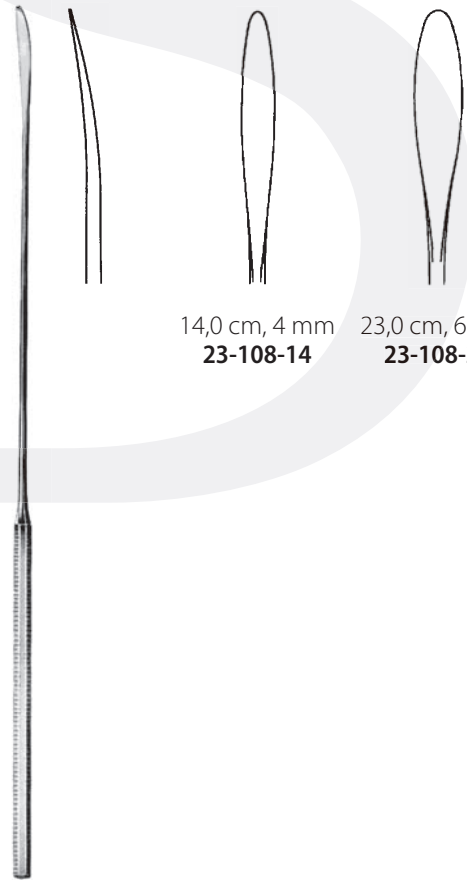

**Schmid**

14,0 cm, 4 mm **23-108-14**  
23,0 cm, 6 mm **23-108-23**

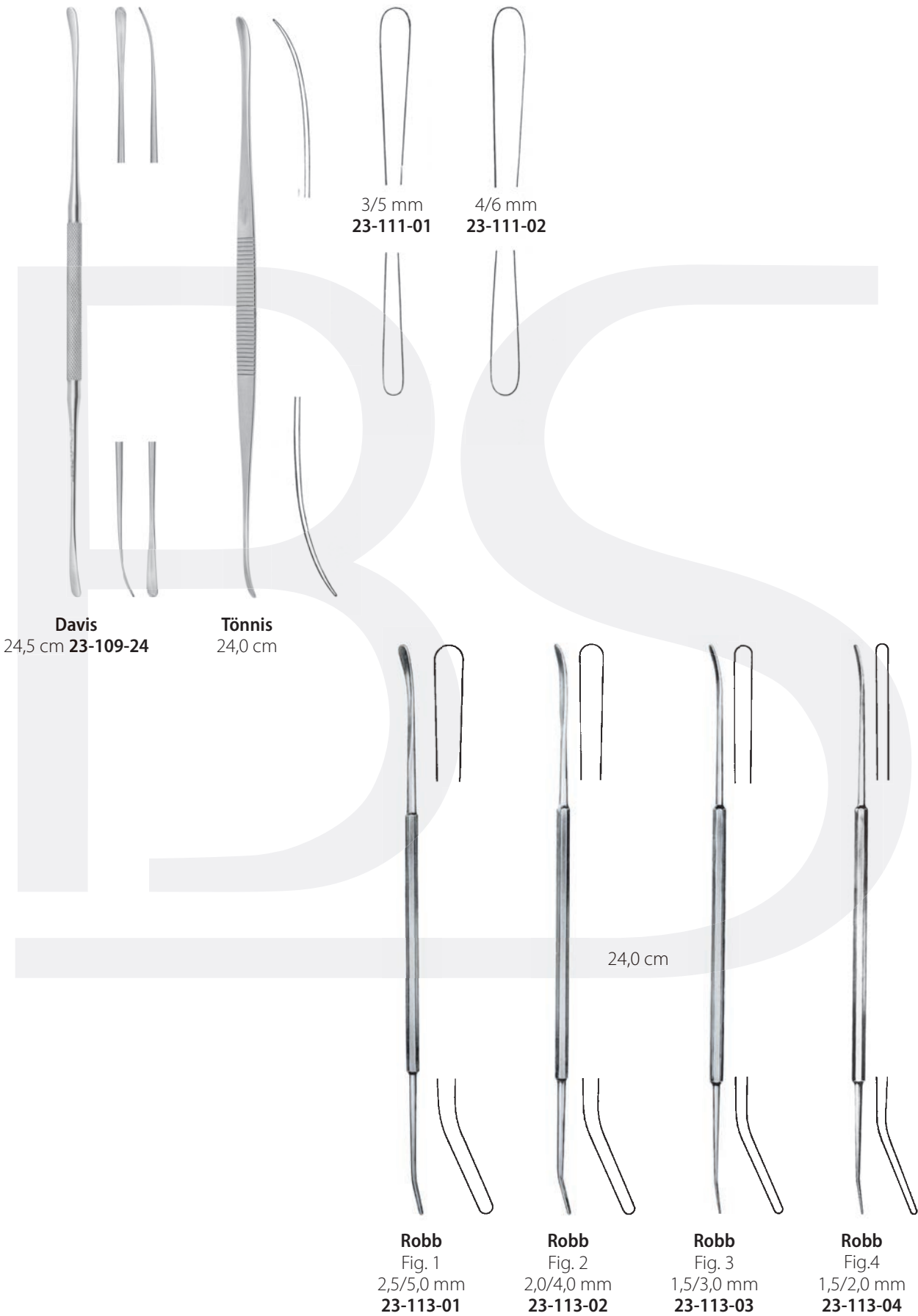





**Rumel-Belmont, 32,0 cm**  
Ø 3,2 mm **23-130-32**  
Ø 4,0 mm **23-130-40**  
Ø 6,4 mm **23-130-64**



**Cooley**  
rechts/right  
45x48 mm  
24,5 cm **23-200-24**



**Cooley**  
rechts, gezahnt/right, serrated  
45x48 mm **nach innen gebogen**/curved inwards  
24,5 cm **23-201-24**



**Cooley**  
links/left  
25x46 **nach außen gebogen**/curved outwards  
25,5 cm **23-202-25**



**Cooley**  
rechts, gezahnt/right, serrated  
24,0 cm 45x30 mm **23-203-24**  
24,0 cm 45x35 mm **23-204-24**

# Klingenbecher und Klingenthaler Scalpel Breaker and Holder

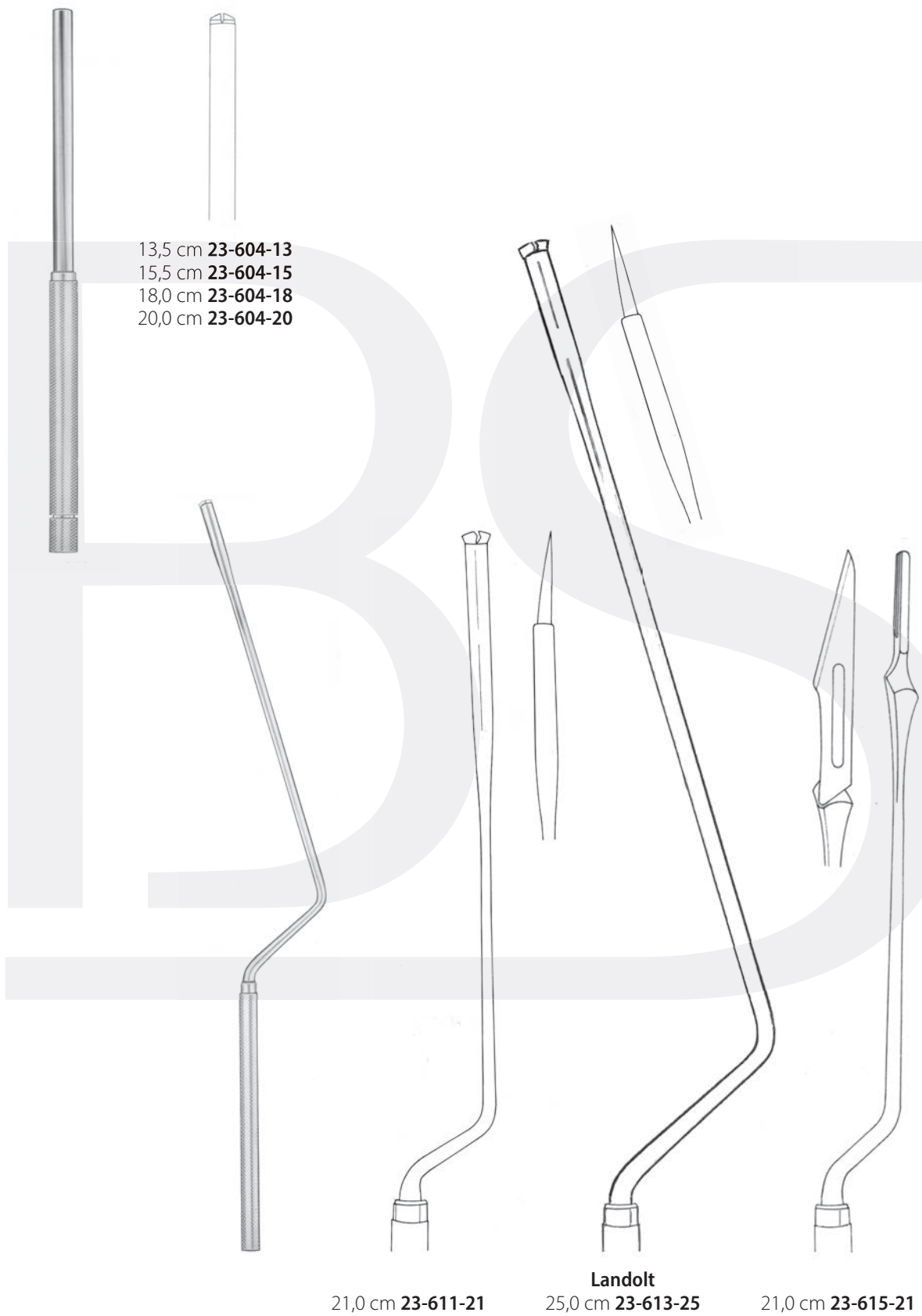

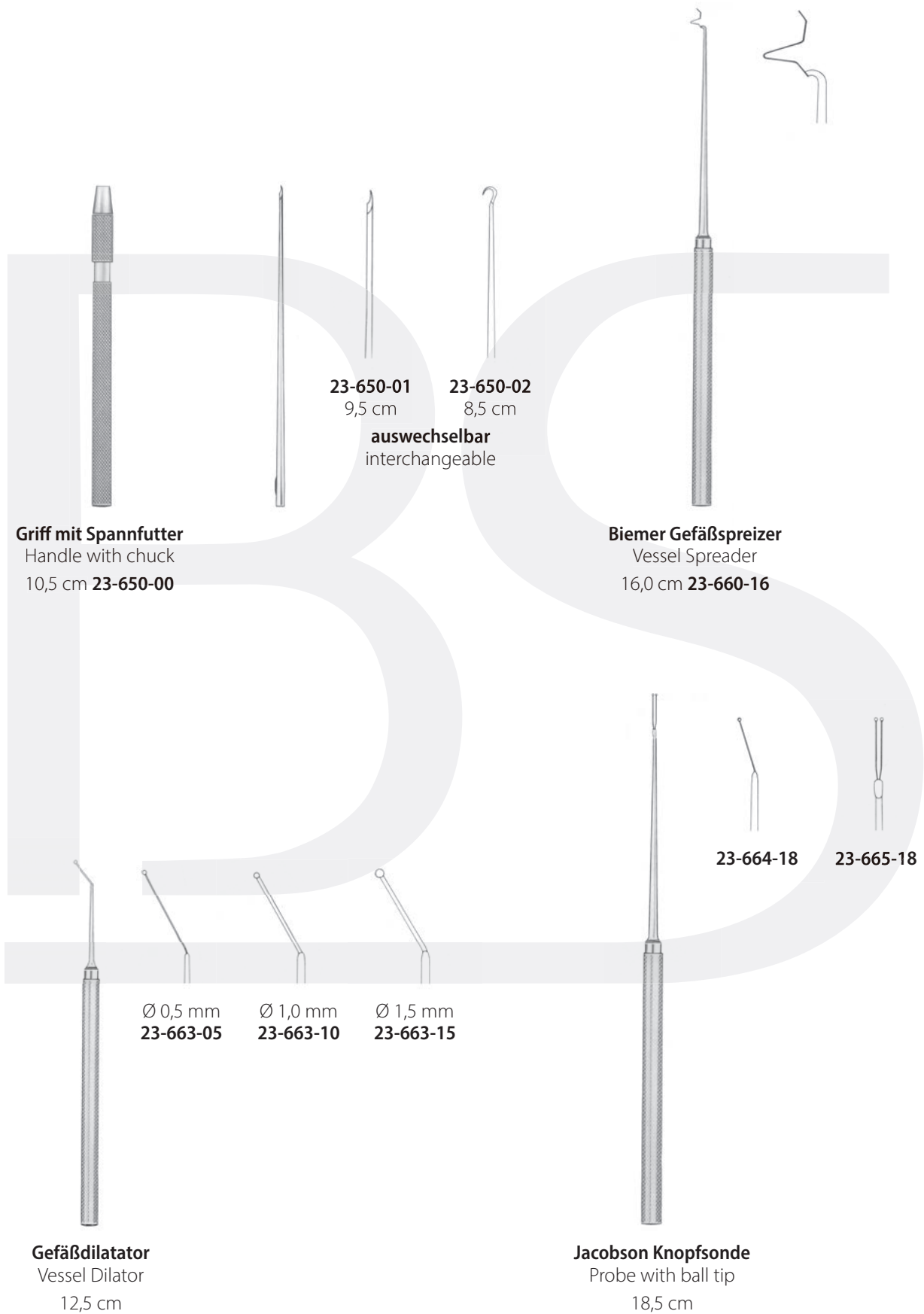

**Fadengabel, Sonden und Hakchen**  
Suture Pusher, Probes and Hooks

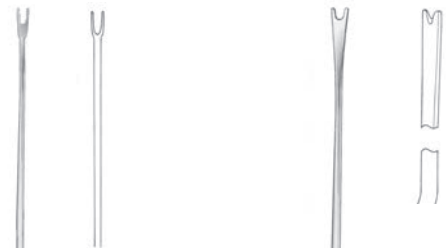

**Jacobson**  
Fadengabel/Suture Pusher  
18,5 cm **23-666-18**

**Caspar**  
Fadengabel/Suture Pusher  
23,0 cm **23-667-23**



mit Schutzkappe  
with guardi

**Gewebekralle**  
Tissue Picks  
Ø 1,8 mm  
18,5 cm **23-674-18**

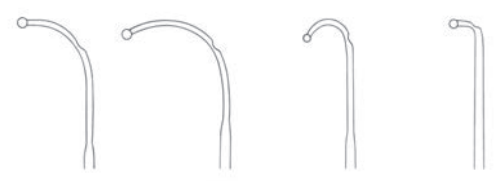

**Yasargil**, 18,5 cm

Fig.1 **23-671-01** Fig.2 **23-671-02** Fig.3 **23-671-03** Fig.4 **23-671-04**



**Krayenbühl**, 18,5 cm

Fig.1 **23-673-01** Fig.2 **23-673-02** Fig.3 **23-673-03** Fig.4 **23-673-04**



90° **gebogen** curved **18,5 cm 23-675-01**  
90° **abgewinkelt** angled **23-675-02**

**Scharfes Hakchen**  
Sharp Hook

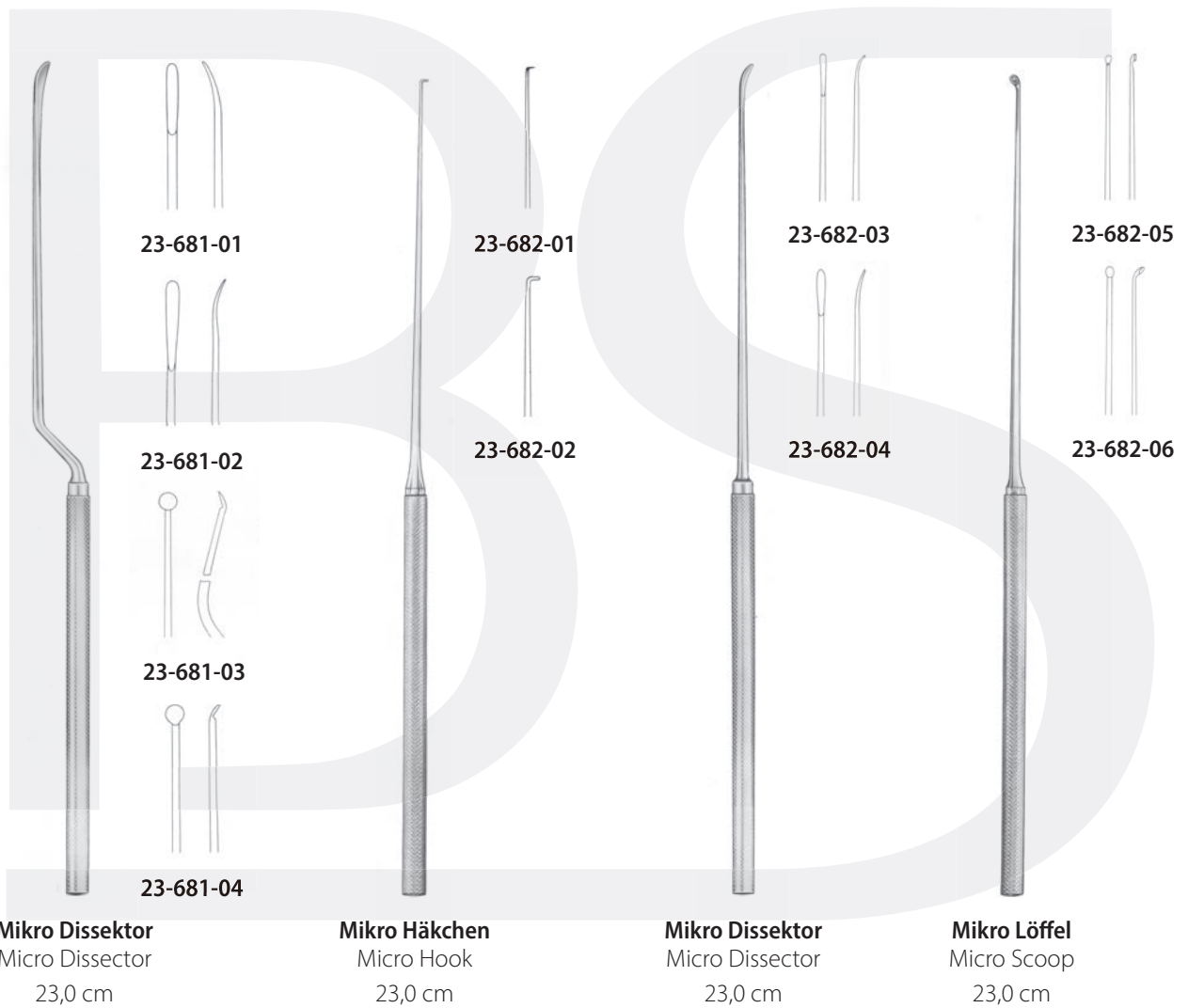

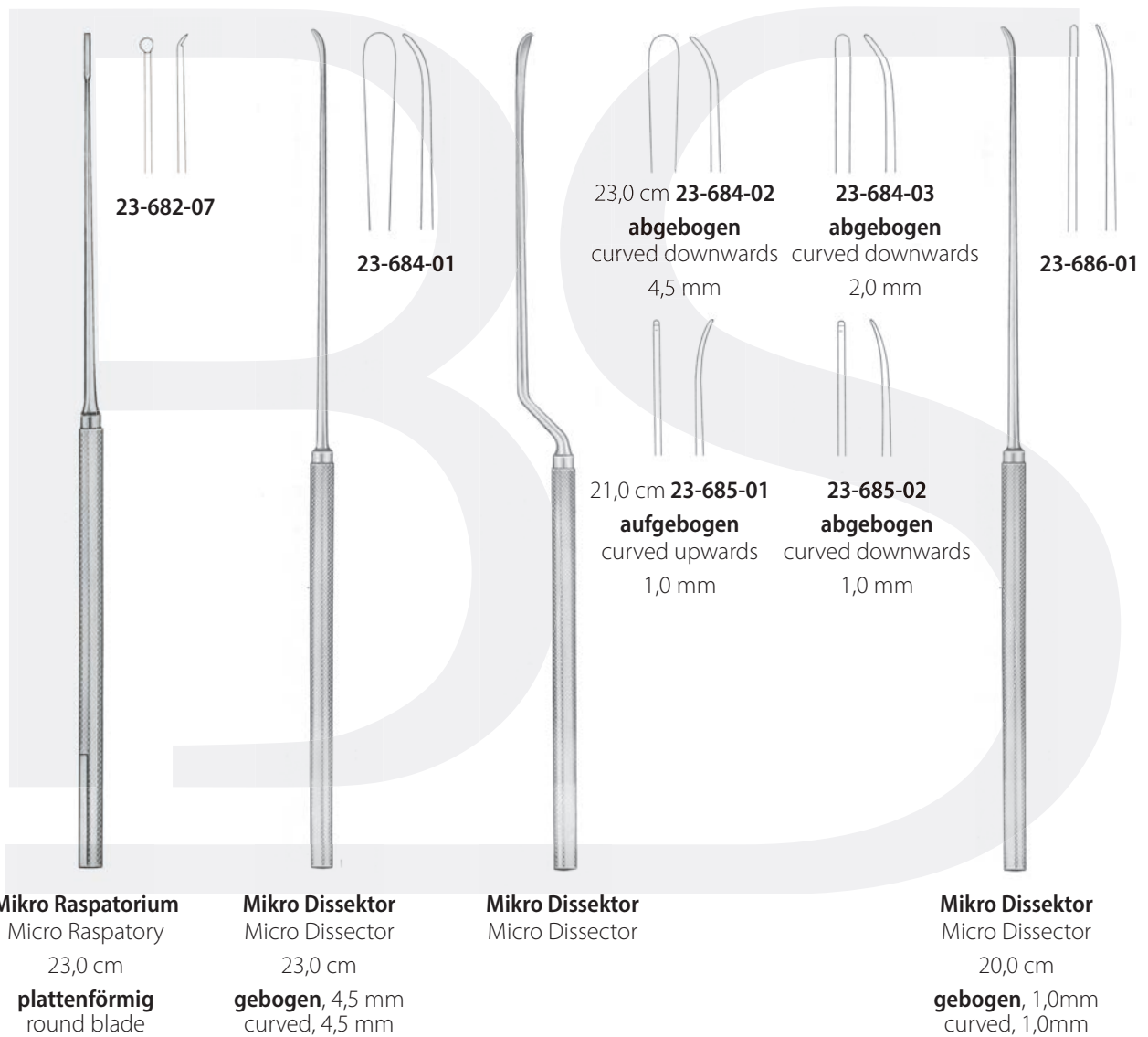
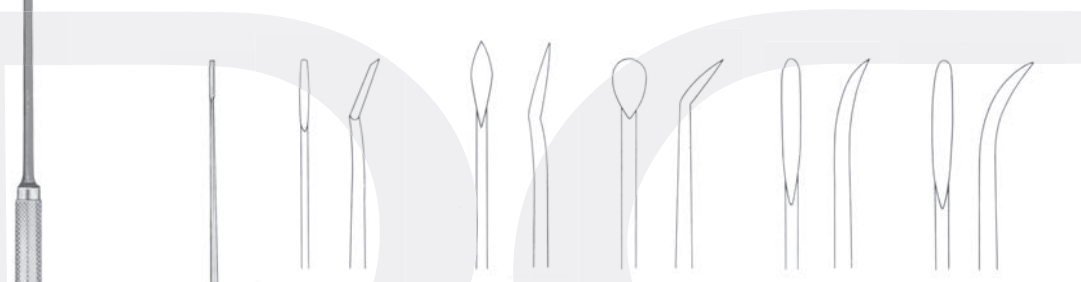



Fig. 1 23-688-01    Fig. 2 23-688-02    Fig. 3 23-688-03    Fig. 4 23-688-04

**geknöpft, isoliert**  
probe-end, insulated



**abgewinkelt**    **abgewinkelt**    **abgewinkelt**    **gebogen**    **gebogen**  
angled    angled    angled    curved    curved  
23-692-01    23-692-02    23-692-03    23-692-04    23-692-05

**Caspar-Explorationshäkchen**  
Caspar - Exploration Hook  
24,5 cm

**Yasargil Mikro-Raspatorium**  
Micro Raspatory  
18,5 cm





**gebogen**    **gebogen**    **aufgebogen**  
curved    curved    curved upward  
23-693-01    23-693-02    23-693-03



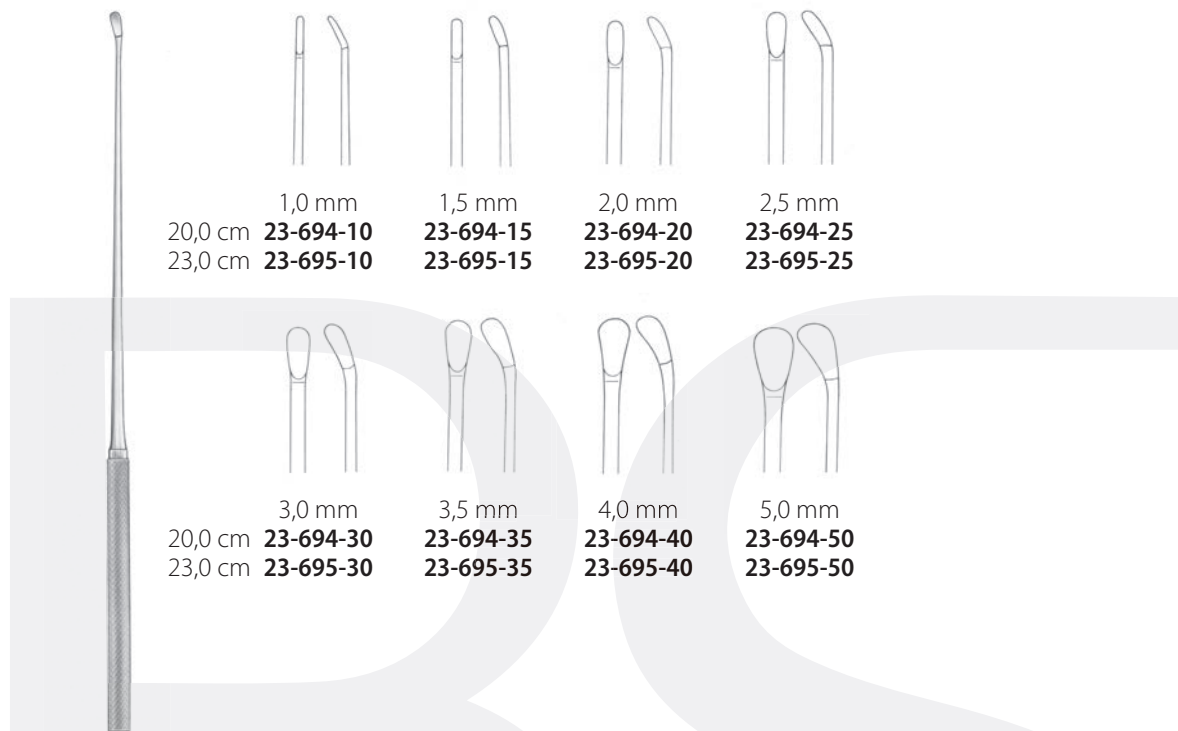

**Yasargil Mikro-Raspatorium**  
Micro Raspatory  
18,5 cm

**Yasargil scharfer Mikro-Löffel**  
Micro Scoop  
18,5 cm 23-693-04











				
	1,0 mm	1,5 mm	2,0 mm	2,5 mm
20,0 cm	<b>23-694-10</b>	<b>23-694-15</b>	<b>23-694-20</b>	<b>23-694-25</b>
23,0 cm	<b>23-695-10</b>	<b>23-695-15</b>	<b>23-695-20</b>	<b>23-695-25</b>

				
	3,0 mm	3,5 mm	4,0 mm	5,0 mm
20,0 cm	<b>23-694-30</b>	<b>23-694-35</b>	<b>23-694-40</b>	<b>23-694-50</b>
23,0 cm	<b>23-695-30</b>	<b>23-695-35</b>	<b>23-695-40</b>	<b>23-695-50</b>

**Samii Tumormesser**  
Tumor Knife

				
	1,5 mm	3,0 mm	4,5 mm	6,0 mm
20,0 cm	<b>23-696-15</b>	<b>23-696-30</b>	<b>23-696-45</b>	<b>23-696-60</b>
23,0 cm	<b>23-697-15</b>	<b>23-697-30</b>	<b>23-697-45</b>	<b>23-697-60</b>

		
	1,8 mm	2,5 mm
23,0 cm	<b>23-698-18</b>	<b>23-698-25</b>

**Samii Tumormesser**  
Tumor Knife

